

Instruction Book

ESSEX

SUPER-SIX



MAY

1928

HUDSON MOTOR CAR COMPANY

DETROIT, MICHIGAN, U. S. A.

Foreword

The owner's greatest contribution to the long life and satisfactory operation of a motor car is to assure himself that it is regularly and adequately lubricated. Too much importance cannot be attached to this simple but essential rule.

Hudson-Essex cars are soundly and ruggedly built, and, if given the attention which they deserve, will prove themselves as among the most economical motor cars, in total costs, which may be found in the market.

Both for periodic inspection and for adjustments which will keep the mechanism at best efficiency, it is suggested that the cars be taken to authorized Hudson-Essex Service Stations, where skilled and trained mechanics will be found.

Only genuine Hudson-Essex replacement parts should be used.

The suggestions in this Instruction Book cover all the operations an owner should attempt; all work which is not entirely and thoroughly understood should be left to authorized Hudson-Essex Service Stations.

Protect Your Car Against Theft

All Hudson and Essex cars are provided with locks as a means of protection against loss by theft. This protection, however, fails to a great extent if the owner does not keep his car locked at all times when it is unoccupied. A professional thief will often steal a car regardless of theft protection devices, but the petty thief or the joy rider cannot get away with a locked car.

Theft insurance on an automobile does not prevent theft, and the fact that a car is insured should not cause the owner to leave his car unprotected against theft, because this only aids the automobile thief. Insurance rates would be lower if fewer cars were stolen, and the number of stolen cars can be reduced by using the locks provided by the manufacturers; therefore—

LOCK YOUR CAR

Warranty

The factory obligation with respect to replacement of alleged defective parts is fully covered by our warranty as follows:

“We warrant the automobiles manufactured by us to be free from defects in material and workmanship under normal use and service, our obligation under this warranty being limited to making good any part or parts thereof which shall, within ninety (90) days after delivery of such automobile to the original purchaser, be returned to us with transportation charges prepaid, and which our examination shall disclose to our satisfaction to have been thus defective.

“This warranty is expressly in lieu of all other warranties expressed or implied, and of all other obligations or liabilities on our part, and we neither assume nor authorize any other person to assume for us any other liability in connection with the sale of our automobiles.

“This warranty shall not apply to any Essex automobile which shall have been repaired or altered outside of our factory in any way so as, in our judgment, to affect its stability or reliability, or which has been subject to misuse, negligence, or accident.

“We make no warranty whatever in respect to tires, rims, ignition apparatus, tops, upholstery, horns or other signaling devices, batteries, speedometers, or other trade accessories.”

HUDSON MOTOR CAR COMPANY
Detroit, Michigan

The factory does not participate in any labor costs incident to the replacement of parts under the warranty. The warranty under which Essex motor cars are sold will be interpreted by the Distributor or Dealer from whom the car was purchased. If you are touring and require service, be sure and get in touch with your nearest authorized Essex Distributor or Dealer.

INDEX

	Page
Accessories	30
Carburetor	19
Care of Finish	28
Coach Adjustable Front Seat	26-27
Cooling System	19
Corrective Data	29
Electrical System	14
Ignition Timing	15
Wiring Diagram	18
General Inspection—	
Brake Adjustments	22
Chain	20
Spark Plugs	30
Spring Clips	21
Spring Shackles	21
Steering Gear Adjustment	9
Valve Tappets	30
Wheel Alignment	22
Headlamp Adjustments	23-24-25
Information	30
Lighting Switch	10
Lubrication Chart	16-17
Lubrication Instructions	8
Clutch	10
Generator	13
Horn	13
Ignition Distributor	13
Motor	8
Rear Axle	12
Starting Motor	13
Steering Gear	9
Transmission	11
Universal Joints	12
Operating Instructions	7
Starting Instructions	7
Storage Battery	15
Warranty	5
Winter Driving	28

LICENSE DATA

Car serial number (see plate on front of dash under hood).
 Engine serial number (stamped on left side of cylinder, near water inlet elbow).
 Number of cylinders—6.
 Diameter of bore— $2\frac{1}{16}$ in.
 Stroke— $4\frac{1}{2}$ in.
 Standard horsepower rating for license purposes—17.32.
 Piston displacement—153.15 cu. in.
 Weight: Coach 2560; Sedan 2660; Coupe 2535; Roadster 2365; Phaeton 2305.

TIRES

Inflate front tires 28 lbs. Inflate rear tires 32 lbs.
 Check pressures once a week.

Starting the Motor

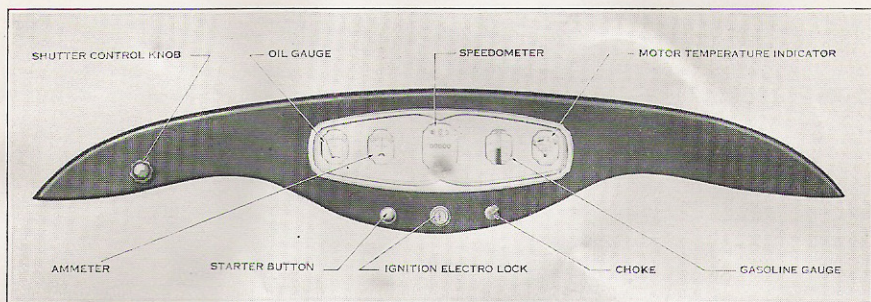

TO START THE MOTOR—Pull out the choke button, insert the key in the ignition electrolock and turn it $\frac{1}{4}$ turn clockwise, then pull out the starter button. The illustration above shows the location of these items. Care should be taken in the use of the choke button, pulling it out only far enough to start the motor and pushing it in as far as possible, consistent with smooth motor operation as soon as the motor has started. The throttle lever at the top of the steering column should be moved slightly upward if the motor is inclined to stall.

To obtain maximum performance and efficiency the shutter control button should be regulated so that the motor temperature will agree with the directions on the motor temperature indicator on the instrument board.

Operating Instructions

The care given to a motor car during its first 1000 miles governs, to a large extent, the length and satisfaction of its service.

All moving parts are closely fitted and adjusted. Higher speeds must be approached gradually to give these parts an opportunity to properly "run in" and insure perfect bearing surfaces. During the first few hundred miles, sustained high car speeds should not be indulged in; nor should the motor be raced or speeded up while the car is at rest.

We recommend that the oil in the crankcase be completely changed after the first 250 miles and every 500 miles thereafter. Other parts of the chassis should be lubricated according to the instructions given in the following pages of this book.

Strict adherence to the following suggested car speeds with respect to speedometer mileage will amply repay you in improved performance, and will minimize your future maintenance costs.

Speedometer Reading

- 0 to 250 miles—Do not exceed 35 m. p. h. high gear; 15 m. p. h. intermediate gear.
- 250 to 500 miles—Do not exceed 40 m. p. h. high gear; 20 m. p. h. intermediate gear.
- 500 to 1000 miles—Do not exceed 45 m. p. h. high gear; 20 m. p. h. intermediate gear.

IMPORTANT—Do not under any consideration attempt to maintain a high rate of speed until the motor is thoroughly warmed up, the oil gauge showing pressure, and you are sure that there is plenty of good oil in the crankcase.

General Lubrication Instructions

Motor Lubrication

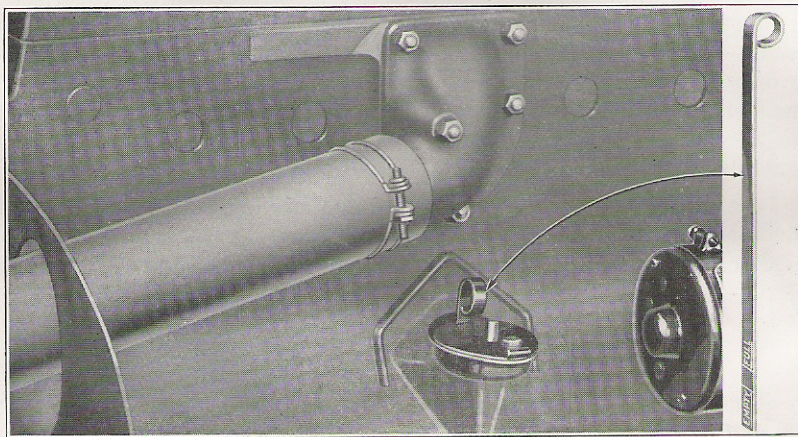

Use only high-grade oil of heavy body.

In cold weather use only high-grade heavy body oil which will flow at low temperatures.

Consult your dealer if you are in doubt as to what oil to use.

The oil gauge must always register when the motor is running. To determine the amount of oil in the reservoir, pull out oil level gauge, shown above, wipe it clean, then turn slide and drop gauge into reservoir. When withdrawn, the exact oil level will be shown.

Every 250 miles add oil as found necessary to bring contents up to "full" mark. Drain the reservoir and replenish with new oil at 500-mile intervals, adding 5 quarts.

Steering Gear

The filler plug "A" should be removed and the gear case filled with a high-grade heavy bodied gear oil (which will remain fluid in cold weather). Any excessive play which may develop due to wear after extensive

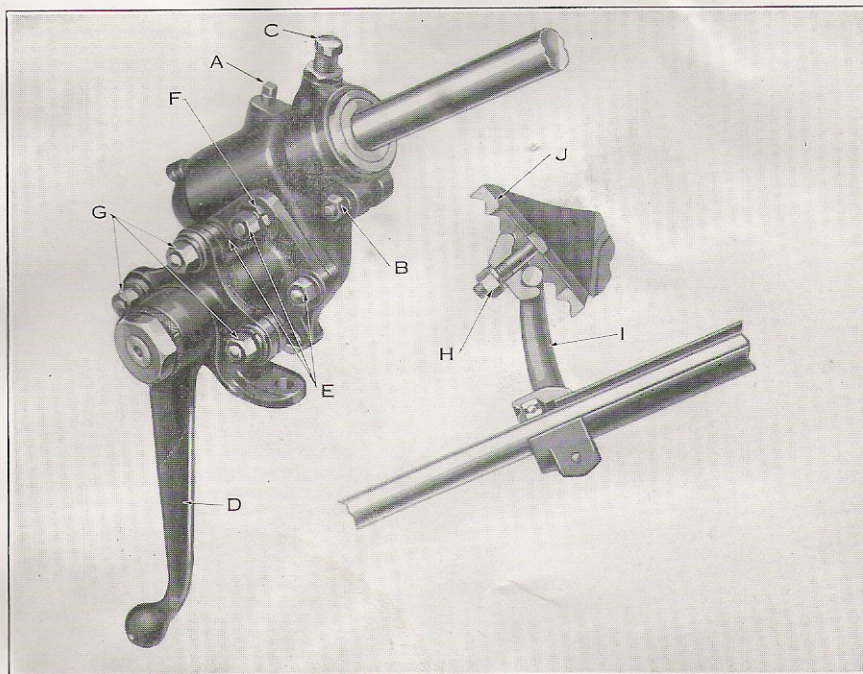

service can be eliminated by the following adjustments. These should be made with both front wheels off the floor.

To remove end play from main column: Loosen clamp bolt "B" one-half turn, loosen clamp nut on adjusting screw "C" and turn adjusting screw "C" down as far as possible without stiffening the action of the steering wheel when turned through its entire movement. Care should be used when doing this to turn screw "C" downward only, as it must be in positive contact with bushing sleeve when the adjustment is completed. The clamp bolt "B" should then be tightened securely.

To remove play in mesh of worm and cross shaft roller: Locate the wheels in a straight ahead position, disconnect drag link from steering arm "D" and shake arm to determine the amount of play. Loosen nuts "E" ($\frac{1}{4}$ turn only). Turn eccentric sleeve "F" to right or clockwise only in gradual stages, noting results by shaking steering arm at each step and using care at last step to turn sleeve just sufficiently to remove play and no further. Securely tighten nuts "E."

To change position of steering wheel to suit requirements of driver: Loosen frame bracket stud nuts "G," cowl bracket nut "H;" set steering wheel at desired position, being sure that bracket "I" is at bottom of groove in bracket "J" when nut "H" has been tightened. Securely tighten nuts "G."

Lighting Switch

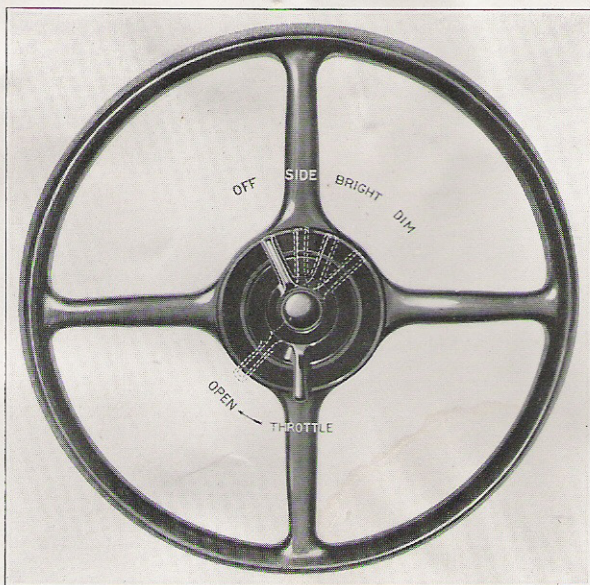

The lighting switch is located at the top of the steering column; all the lights being controlled at this point.

It is only necessary to move the lever to the dim or bright position, as shown in the illustration, in order to have the proper driving lights.

Clutch

Clutch lubricant should be inspected and replenished if necessary every 2500 miles, or oftener if the action becomes harsh, as follows:

Remove one bolt at side of flywheel pan, also cap screw holding rear end of pan to transmission case, and swing pan to one side.

Turn flywheel until square head filler plug in clutch cover is at its lowest position.

Remove plug and with an oil gun fill with 8 ounces of light motor oil to the bottom of the plug opening. In winter use 6 ounces light motor oil and 2 ounces kerosene. It is important that plug opening be at its lowest level, otherwise too much oil will be introduced.

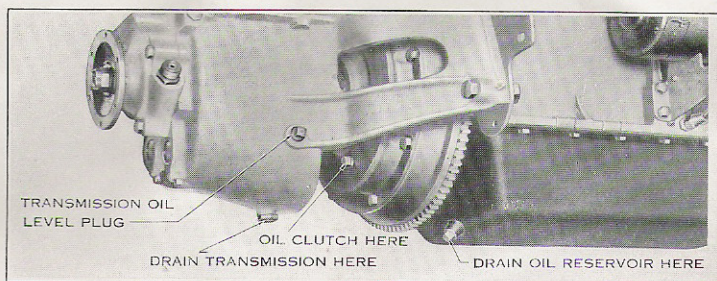

Replace filler plug, tighten securely and fasten flywheel pan in position.

A free movement of at least $\frac{3}{4}$ " should be maintained between the clutch pedal and the bottom of the toe board at all times. When necessary, adjustment may be made by lengthening the link connecting the pedal shaft lever with the throwout yoke.

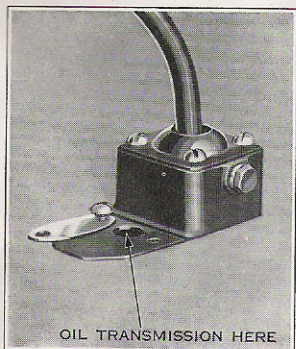

Transmission

The transmission oil filler is located directly behind the gear shift lever housing, as shown in the illustration. It is only necessary to remove one screw and loosen the other in order that the cover plate may be swung to one side, giving free access to the filler opening.

For transmission lubrication, we recommend the use of high-grade heavy body motor oil which will meet the specifications listed on page 8 under Motor Lubrication.

Do not use grease. Oil should not be carried above the level of the test plug, which is located on the right-hand side of the transmission case. Remove this plug and fill only until oil drips from the opening. Every 5000 miles the transmission should be drained, flushed out with kerosene and refilled with new oil to the proper level.

Rear Axle

The rear axle drive gears and differential are lubricated by removing the large pipe plug in the housing cover. The oil supply in the housing should be kept up to the level of the filler plug opening.

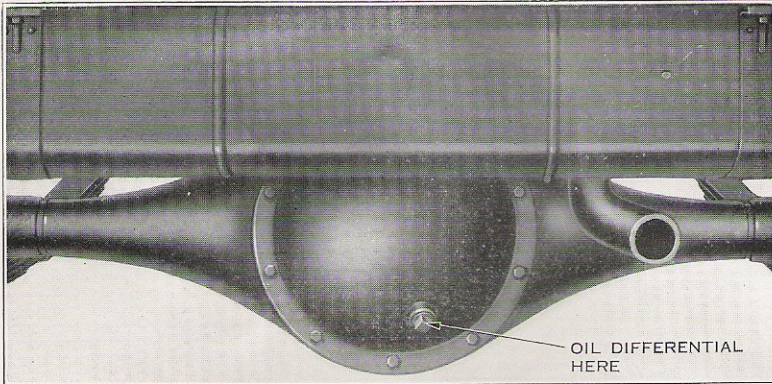

Use only good rear axle or differential oil that will flow at low temperatures. Do not use grease. Once a year drain axle by removing lower cap screw from housing cover and refill with new oil.

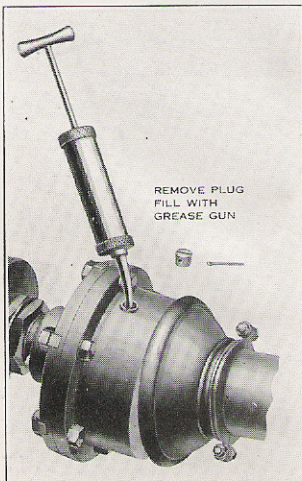

Universal Joints

The universal joints, because of the severe service to which they are put, require adequate lubrication attention. Every 2000 miles remove plugs and fill with fiber grease.

Electrical Units

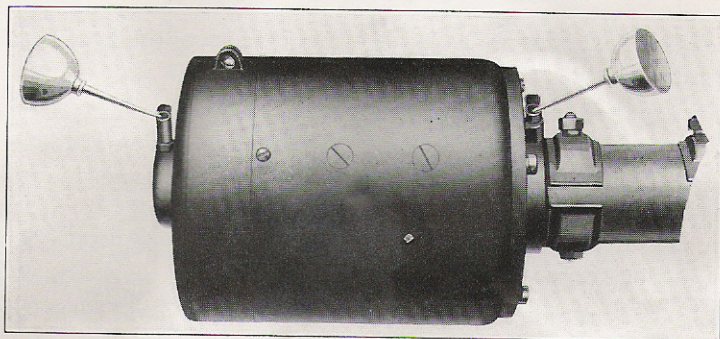

Generator

Three or four drops of light motor oil at points designated every 1000 miles.

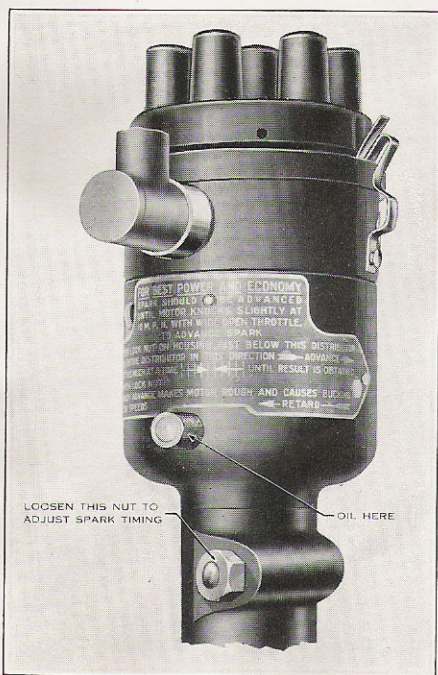

Distributor

Fill distributor base with motor oil every 5000 miles to the level of the oil cup.

Starting Motor

The starting motor is fitted with oilless bearings and requires no lubrication.

Horn

The horn should be lubricated occasionally by removing the cover screw and cover and placing a few drops of light oil in the oil holes provided.

Electrical System

The electrical system requires little attention other than that of proper lubrication.

Within five days after delivery of a new car the purchaser should take it to the nearest Electric Auto-Lite Service Station in his territory for registration and inspection of the electrical units. An identification card will be received by him which will entitle him to free inspection service on the electrical apparatus at any Electric Auto-Lite Service Station during the guaranty period.

The electrical units covered by the Electric Auto-Lite Company Guaranty include: Starting Motor, Generator, Distributor, Coil and Switch.

The wiring employed in the light circuits is protected by a 20-ampere fuse located on the dash. It is accessible by lifting the hood on the driver's side. If for any reason the lights do not burn, examine this fuse; if necessary, replace with a spare of the proper capacity.

Persistent blowing of the fuses indicates a short in the wiring, and the circuits should be inspected by your dealer at the earliest opportunity.

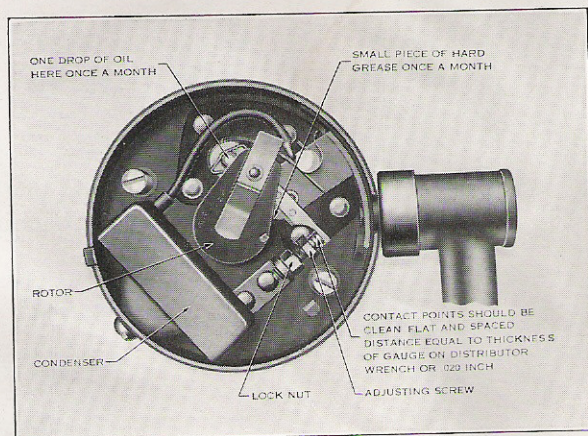

The ignition distributor requires no attention other than that pointed out in the illustration.

Ignition Timing

The ignition distributor is equipped with an automatic spark control device which automatically times the ignition according to the motor speed. This renders a hand spark advance unnecessary. The initial setting at the factory is correct and should not be altered unless these parts have been removed or disturbed.

To check the spark timing when necessary, proceed as follows: Remove No. 1 spark plug and crank the motor by hand until the rush of air from the plug opening indicates that the piston is coming up on compression stroke. This can readily be determined by placing a finger over the spark plug opening. The motor should then be turned very slowly until the dead center mark on the flywheel coincides exactly with the lower edge of the square sight hole on the right side of the motor rear plate. When this is done, the motor is on dead center.

Remove the distributor cap and rotor, and see that the contact points are just separating.

To adjust, if necessary, loosen the nut on the distributor lock pin, shown in the illustration on page 13, and turn the distributor slightly in the proper direction. Turn the distributor to the right, or clockwise, to retard the ignition; to the left, or anti-clockwise, to advance. Then re-tighten the lock pin nut.

Storage Battery

Immediately upon delivery of a new car the purchaser should take it to the nearest authorized "Exide" Battery Service Station for an initial inspection.

During the winter months the greater use of lights and the starting motor naturally drains the battery more quickly than in summer. Let your nearest battery station inspect the battery frequently and advise you as to its condition.

Lubrication Chart

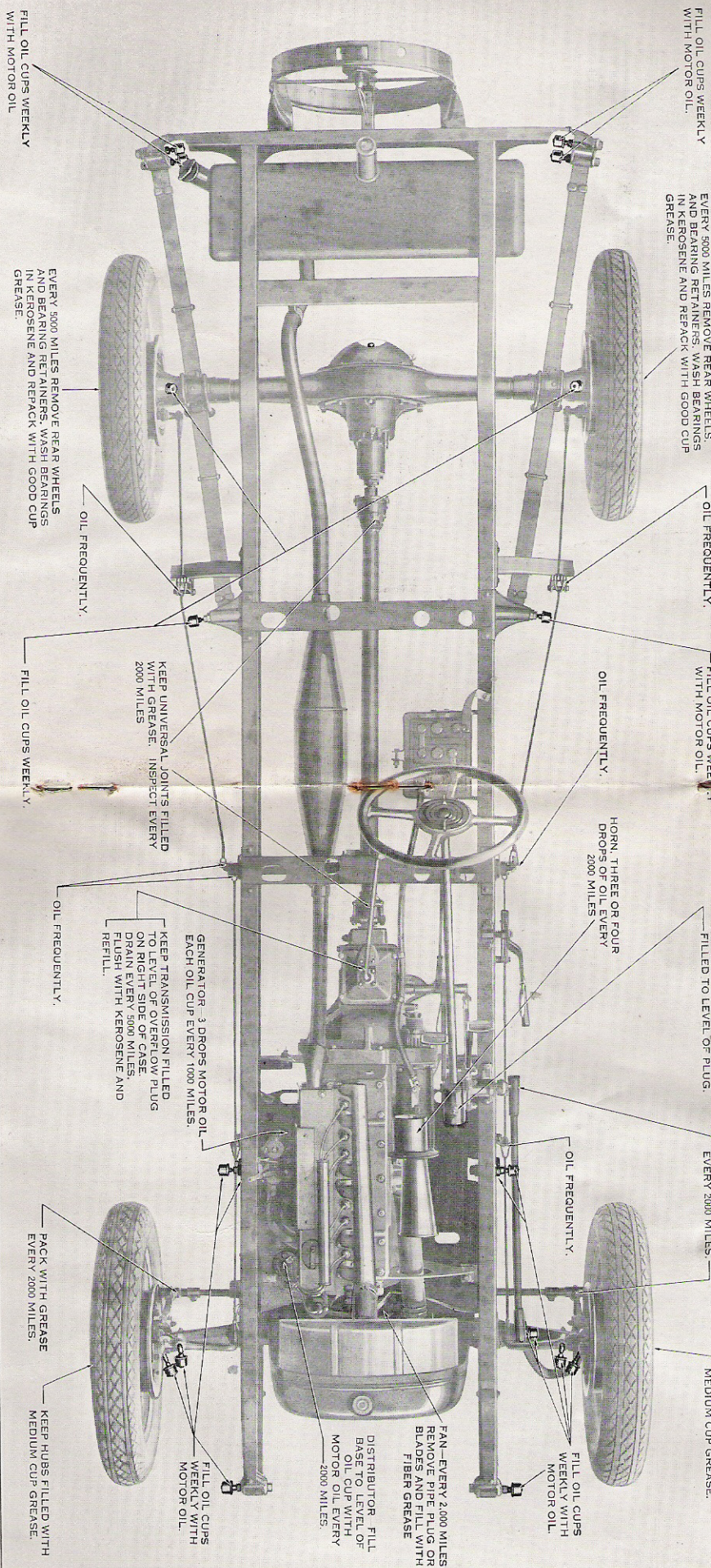

Wiring Diagram

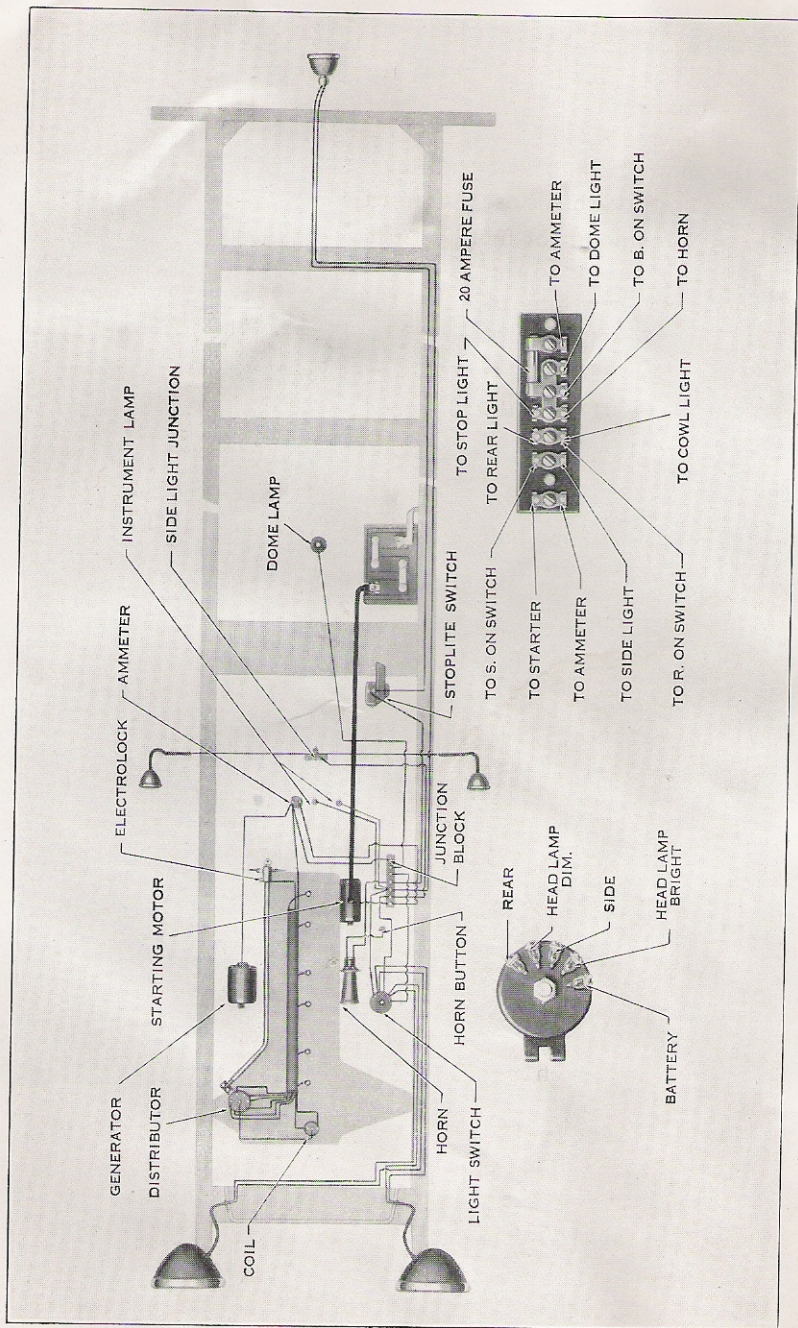

The Carburetor

After a new car has been run approximately two hundred miles it is advisable to alter the carburetor adjustment so the car will operate on a leaner mixture. To adjust the carburetor for best fuel economy, proceed as follows:

Run the motor a sufficient length of time for it to attain a normal running temperature, then close the throttle.

Decrease the amount of fuel by turning the knurled adjusting screw at bottom of carburetor to the left until the motor begins to miss or stalls. This may require several complete turns.

The adjustment should then be reversed, that is, turned to the right, a notch at a time, until the motor fires evenly. This will require about one-half a turn. This one adjustment automatically insures correct carburetion throughout the entire operating range.

In hot weather better performance will be obtained by opening the sliding covers on the hot air stove.

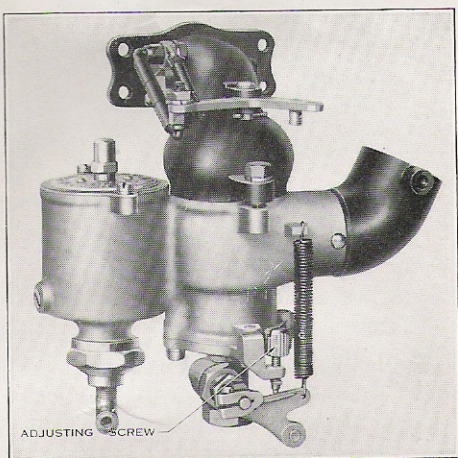

Cooling System

The cooling system should be kept full of pure water at all times. If the water in your locality is known to contain alkali or lime, avoid its use if possible and use rain water.

It is important that the cooling system be drained and thoroughly flushed out with clear water at frequent intervals to prevent the formation of deposits which would tend to obstruct the water passages in the radiator.

Keep the radiator shutters adjusted so as to maintain an efficient operating temperature as indicated by the directions on the motor temperature indicator on the instrument board.

See that the fan belt does not slip. An adjustment is provided for taking up slack.

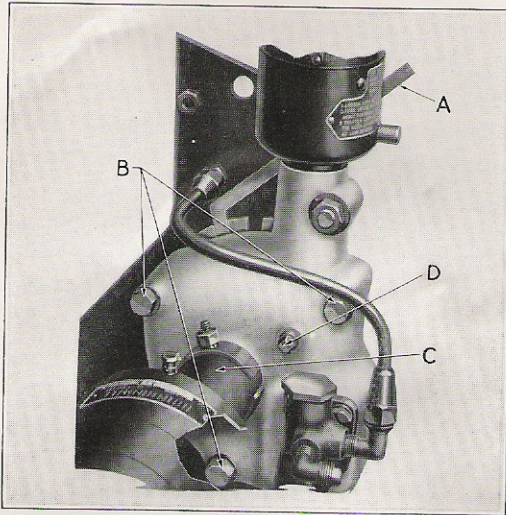

The Chain

The camshaft and accessory shaft are driven by a chain which is provided with means of adjustment. At the expiration of from 500 to 1000 miles driving it is advisable to determine if the chain requires taking up. Subsequent inspections at intervals of 4000 miles are recommended. To inspect chain proceed as follows:

Grasp the rubber coupling on the generator drive shaft "C" and turn to and fro as far as possible. There should be approximately $\frac{1}{8}$ " movement on the circumference.

To adjust chain:

Loosen retaining bolts "B." Note: At certain stages of adjustment the inside top bolt and the bottom bolt, or both, may pass through notches in plate. It will then be necessary to remove these bolts entirely. Insert special tool "A" in notch and turn flange toward you until only necessary play is present. If the two bolts referred to have been removed and cannot be returned, then back off adjustment slightly until they will enter through notch.

It is necessary when the distributor support housing has been removed, but not otherwise, to introduce $\frac{1}{2}$ pint of motor oil through pipe plug opening "D" before running motor.

To remove or replace chain, turn the adjusting eccentric to the point of minimum adjustment and then remove the camshaft sprocket.

The punch marks on the chain should coincide with those on the sprockets, as shown in the view, when properly assembled.

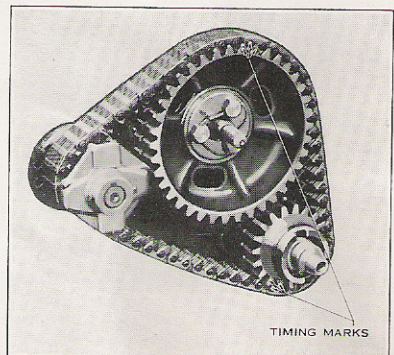

Spring Shackles

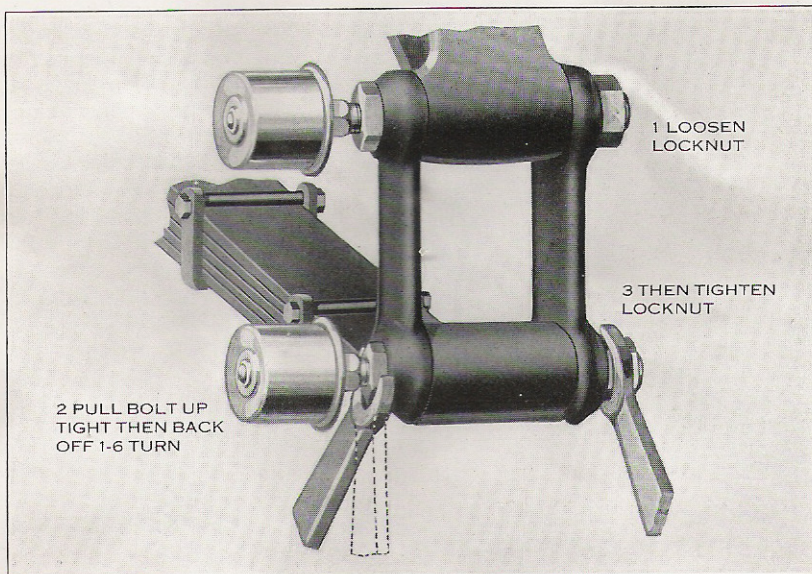

The spring shackles are provided with an adjustment by means of which all play can be taken up in a few minutes and rattles at these points eliminated.

Do not tighten too much or you will interfere with the action of the springs. Follow the instructions given closely.

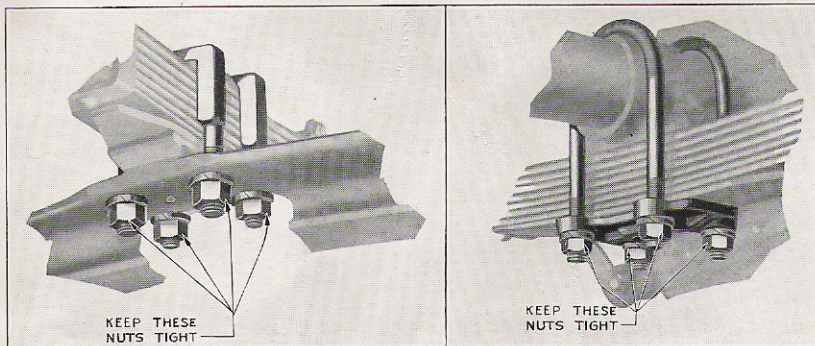

Spring Clips

Spring breakage can usually be attributed to looseness in the spring clips which secure the springs to the axles. It is recommended that these clips be inspected occasionally for tightness.

Brake Adjustments

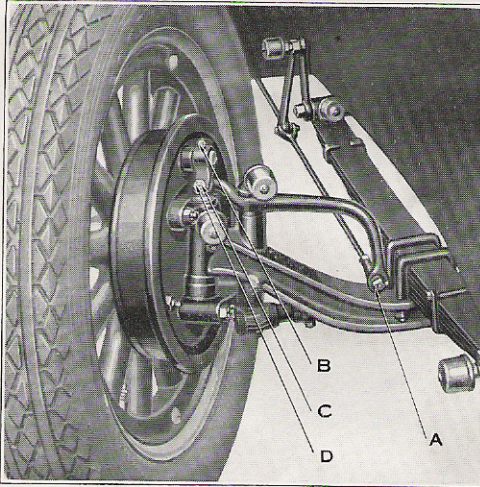

The four-wheel brakes are of the self-energizing internal shoe type and may be adjusted for equalization and ordinary wear as noted below. Another adjustment to compensate for extreme wear which affects the position of the operating levers is provided. This adjustment, however, will only be necessary after long service and should be made by your dealer.

The position of the operating levers and rods must not be tampered with, and the cross shafts, joints and linkage must operate

freely and be well lubricated. It is very important that the drums and brake shoes be free from grease and oil at all times.

Adjustment for Wear

Jack up both front and rear of car so that all four wheels are clear of the floor. Adjust the front brakes first, as follows:

Loosen lock nut "C" on the cam adjusting button "D." Using a screwdriver in the slotted end of the button screw, turn it in until the brake starts to drag, after which back off on the screw until the wheel just turns freely. Tighten lock nut securely and again make sure that the wheel can be turned without brake dragging. After both front wheels have been adjusted in this way, proceed to adjust the rear brakes in the following manner:

Adjust the ball socket nuts on ends of rear brake pull rods, turning them to the right until the brakes start to drag. Now loosen the adjustment until the wheels just turn freely. Note: Be sure that the cross pins in the ball socket nuts rest in the grooves in the brake shaft levers after altering the adjustment.

Equalizing

After adjusting brakes, they should be checked for approximate equalization. With the car jacked up so that all four wheels are off the floor, have someone sit in the driver's seat and hold the brake on lightly. If no one is available for this, the brake pedal should be held in a slightly depressed position by means of a piece of wood of the required length placed between pedal and front seat heelboard. Try the wheels and compare the effort necessary to cause them to turn against the brake action, revolving the wheel always in the forward direction.

If the wheels are unbalanced so that they do not have the same resistance to turning, loosen the adjustment on the tight wheels until the equalization is satisfactory. Guard against over-tightening.

Wheel Alignment

The alignment of the front wheels has a very important bearing on the life of the front tires and on the ease of steering. The alignment can be checked by measuring the distance between the inside of the rims at the front and rear. The distance at the front should be the same as the distance at the rear or range from that to one-eighth inch less.

Should adjustment be necessary loosen clamp bolts in yokes at both ends of tie rod and turn tie rod, taking measurements from time to time until the desired results are obtained. Tighten clamp bolts securely when adjustment is completed.

Headlamp Adjustments

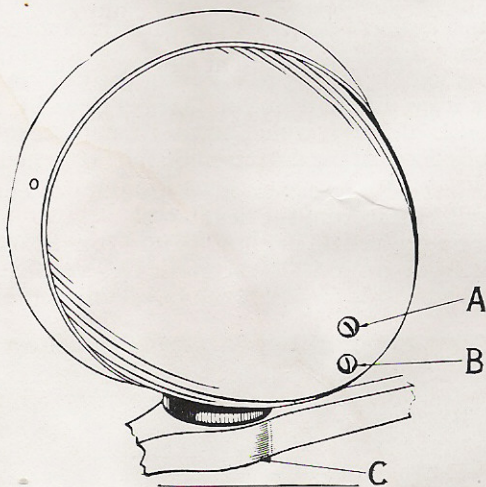

Fig. 1

DESCRIPTION—The Parabeam Headlamp is a complete lighting unit of the type which uses a double filament bulb of 21 c. p. for each filament. The two filaments are spaced $\frac{1}{8}$ -inch apart, above and below the central axis of the bulb. Lighting the lower filament gives the upper or "driving" beam. (Fig. 2.) The upper filament produces the lower or "passing" beam (Fig. 3) for city driving or whenever the upper beam might cause annoyance to others. The lower beam is tilted downward about $2\frac{1}{2}$ degrees from the upper position, or about 1 foot on a wall 25

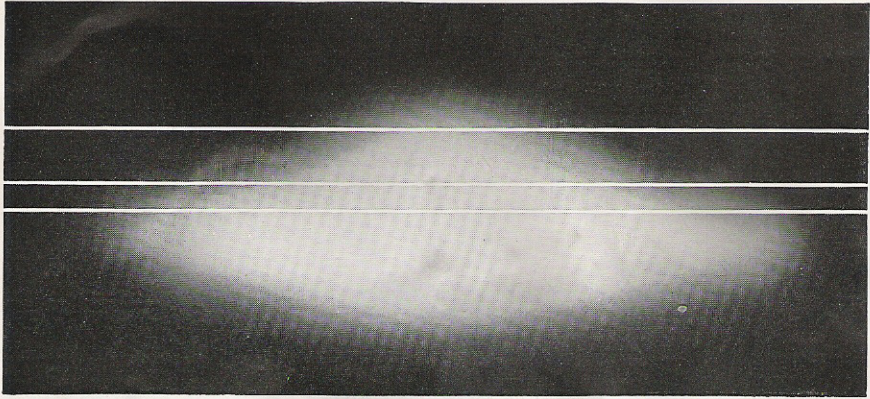

Fig. 2. Single Upper Beam—Lens in Place

feet from the lamp. The two lower white lines in Fig. 3 indicate the maximum and minimum tilt for the top of lower beam.

The headlamp consists of a carefully made outer housing and door, a special variable axis parabolic reflector to tilt and spread the light, and a ribbed or fluted lens designed solely for use with this reflector. In addition to the upper screw "A" (Fig. 1) at the rear for focusing the bulb, an adjustment is provided for raising or lowering the bulb in the reflector to secure best results from different bulbs. This is done by the lower screw "B" (Fig. 1) at back of lamp, which turns a small eccentric, tilting the socket and bulb up or down in the slotted guide tube attached to the reflector.

TO FOCUS: *First*—Place car on level ground or floor, and squarely facing a smooth wall 25 feet from the headlamps.

Second—Mark a horizontal line "A" (Fig. 4) on the wall at the height of headlight bulbs from ground. Next mark two vertical lines from line "A" to the ground, exactly in front of each headlamp center. The distance

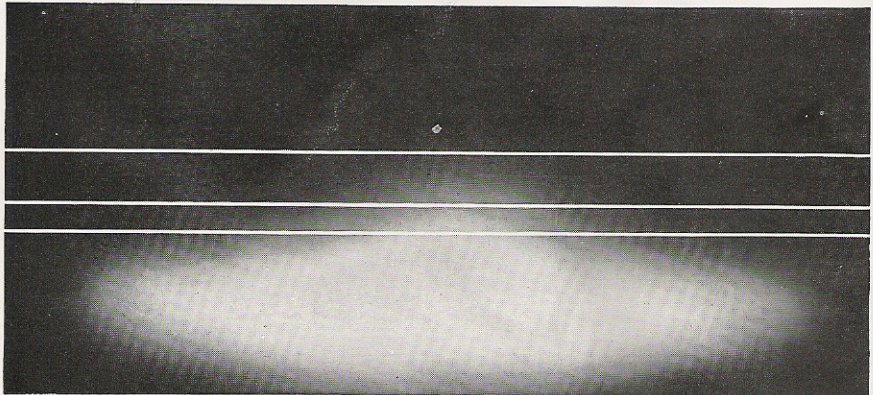

Fig. 3. Single Lower Beam—Lens in Place

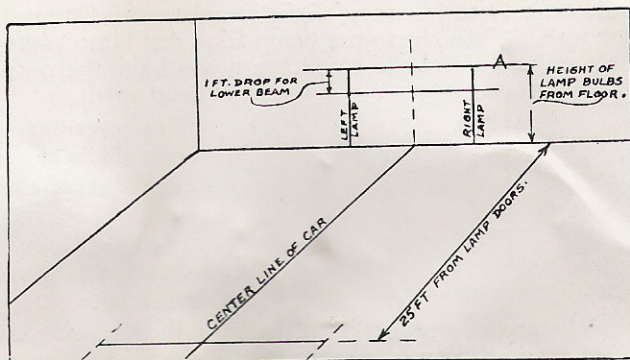

Fig. 4. Car Position

between these vertical lines should be the same as the distance between the headlight bulbs.

Third—With one lamp covered to hide its light, set the lighting control switch at the upper or “driving” beam position and remove the door from the uncovered lamp. Turn the lower of the two screws “B” (Fig. 1) in the back of headlamp (vertical adjustment screw) to the right until the top of the light beam is as low as possible, then turn it to the left one-quarter turn or slightly more. The total adjustment is covered by a half turn of the screw. Turning screw to right raises the bulb in reflector and tends to lower the top of the “driving” beam, producing a flatter cut-off and less tilt to the lower beam. Therefore, set the bulb so that the beam shown in Fig. 5 is obtained by proceeding as follows:

Fourth—Turn the large focus screw “A” (Fig. 1) in center of lamp slowly to left or right until a bright triangular spot like Fig. 5 is obtained. Try removing the bulb, turning it half way around to reverse the position of filaments, and replacing in the socket. This insures the best beam from the bare reflector, since the bulb filaments sometimes vary in length and position.

The top of the triangular light spot should be almost flat or slightly peaked in the center. Now replace the door and lens and fasten firmly.

Fifth—Aim or point the lamp by loosening the nut at “C” (Fig. 1) on lower side of lamp mounting. The center of the beam should strike the vertical line on wall in front of this lamp, and the top of beam should touch line “A” when car is fully loaded. If car is empty, allow at least 4 inches between line “A” and top of light beam. Under no circumstances should any part of the bright beam rise above line “A.”

Sixth—Make sure that the lamp is firmly fastened in position when it is aimed correctly. Then repeat the foregoing operations with the other lamp. The two upper beams should be similar in shape and should strike the wall at the same height from the ground. Now turn the control switch to the lower or “passing” beam position and note whether the cut-off or top of the bright area on wall has dropped about 1 foot. If the amount of drop is considerably less than 1 foot, turn lower screw “B” (Fig. 1)

(vertical adjustment) to left very slightly and try both upper and lower beam on the wall. When the upper beam from one lamp looks like Fig. 2 it is correctly adjusted and the lower beam will have the proper amount of drop or tilt.

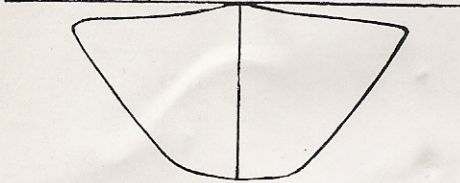
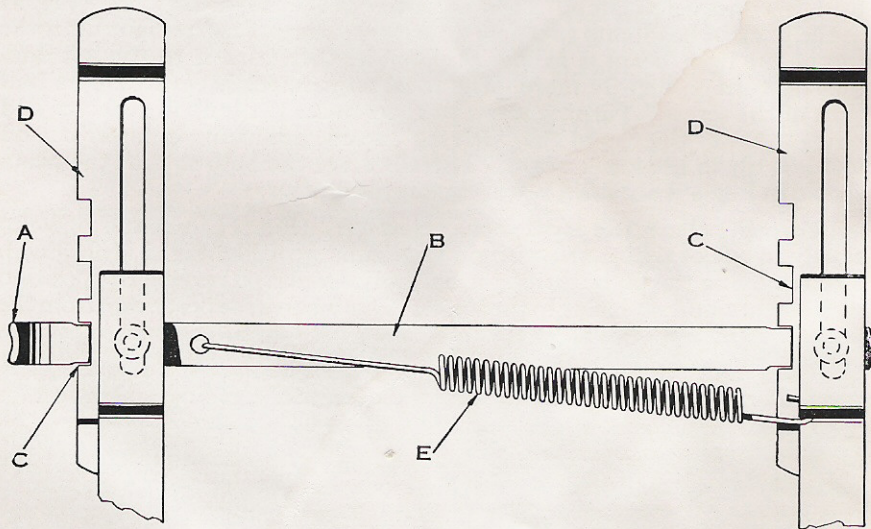

Fig. 5. Upper Beam with Lens Removed

The lower beams project a powerful light close to the car and are of great comfort when meeting another car with glaring lights, since the roadside and ditch are brightly illuminated.

When the lamps are properly adjusted and focused, as outlined, they will meet the legal requirements of most states. However, the range of tilting movement, together with the other adjustments provided, is sufficiently great to permit any necessary deviation from this setting to conform with your local legislation.

Coach Adjustable Front Seat



Description

The front seats in the coach are provided with a mechanism by means of which they may be slid backward or forward by the occupant. The driver's seat may thus be set in any one of three positions, giving varying amounts of leg room, while the passenger seat next to the driver may be slid to the forward position, which allows ample room for passengers to enter or leave the rear of the car. All of these operations may readily be performed while the seats are occupied.

To Operate the Driver's Seat

1. Pull the finger grip "A" outwards. This releases the cross bar "B" from the slots "C" in the runner "D."
2. Slide the seat backward or forward until the cross bar "B" is opposite the front, middle or rear slot as may be desired and release the finger grip. A strong spring "E" pulls the cross bar into the slots and holds it securely in place.

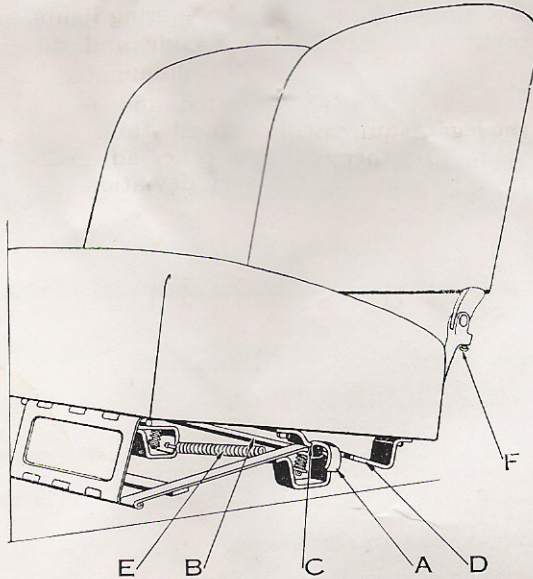

3. These operations may very easily be made when the seat is occupied by first pulling the body towards the steering wheel with the right hand. This tends to slide the seat forward and enables the finger grip to be pulled outward with the left hand. The seat may then be slid backward or forward and the cross bar dropped into the desired slot.

To Operate the Passenger's Seat

Normally this seat is in the extreme backward position which allows ample room for the occupant while riding. When other passengers desire to enter or leave the rear of the car, the occupant of the front seat should grasp the ledge above the instrument board and pull towards him. This will cause the seat to slide forward until there is ample room between the back of the seat and the door hinge pillar for entrance or exit. To return the seat to the normal riding position, it is only necessary to push back with the feet against the toe boards and the seat will slide easily to the extreme back position. When this seat is not occupied, it may be folded entirely forward out of the way.

To Adjust the Tilt of Seat Backs

The backs of both front seats are hinged at the bottom, and adjusting screws "F" are provided to enable the seat back to be inclined forward or backward as may be desired.

Winter Driving

There are two things to take into consideration when operating your car in freezing weather. They are the Lubrication and Cooling Systems.

Lubrication

Oils are affected by temperature. Many oils thicken and the pump will not handle them. Use only an oil that will stand a low cold test in freezing weather. It is recommended that the oil be changed every 500 miles.

Cooling System

When the car is operated in freezing weather, use the anti-freeze mixture we recommend.

For zero temperature		Below zero
Alcohol.....	30%	Alcohol..... 35 to 50%
Water.....	70%	Water..... 50 to 65%
Glycerine.....	32%	Glycerine..... 40 to 60%
Water.....	68%	Water..... 40 to 60%

Do not use kerosene as an anti-freeze.

Capacity of cooling system is $4\frac{3}{4}$ gallons.

If anti-freeze mixture is not used, the water in the system must be completely drained off to avoid damage due to freezing whenever the car is not being operated. The drain is located in the lower radiator tank.

Care of the Finish

The same care should be exercised in washing and cleaning cars finished in lacquer or enamel as is employed in the handling of varnished surfaces. Dry dirt accumulations should not be wiped off but should be softened and removed by thoroughly soaking the body with flowing water, applied under light pressure.

Careful washing of the car, followed by the use of a polish especially prepared for lacquer or enamel finishes, will maintain a high luster and preserve the finish. The use of polishes containing strong abrasives should be avoided, as they are particularly destructive to the striping employed. Anti-freeze solutions containing alcohol when accidentally spilled on the finish should be immediately washed off with clear water to prevent spotting, as alcohol is a solvent of lacquer.

Corrective Data

Starter Does Not Work

1. Loose battery connections. The terminal clamps on the battery should be kept tight and coated with vaseline to prevent corrosion.
2. Storage battery run down. Let your battery station advise.

Failure of Motor to Start

1. Ignition contact points dirty. See page 14. Clean by pulling a piece of fine (00) sandpaper between them.
2. Motor flooded with gasoline caused by excessive choking. Crank motor with choke button all the way in until motor fires.

Reasons for Motor Missing

1. Driving with cold motor. Close radiator shutter until it warms up.
2. Too rich a mixture. See that choke button is not pulled out.
3. Fouled spark plugs. Clean them and set points at .028 of an inch clearance.
4. Tappets set too close together so that valves will not close. See page 30.

Reasons for Overheating

1. Water supply low.
2. Cooling system dirty. Dissolve about two pounds of sal soda (washing soda) in hot water and pour in radiator. Run car for about one-half hour, then drain and flush twice with pure water.
3. Hose connections in bad shape. Remedy is to replace.
4. Lack of motor oil. See that oil gauge on dash is working and that oil reservoir contains sufficient oil.
5. Loose or broken fan belt.
6. Late ignition timing. See page 15.

In General

1. Clutch slipping. Too much oil in clutch—drain to proper level. See page 10. Clutch grabbing. Insufficient oil—re-oil according to instructions on page 10.
2. Rear axle noise. See that differential has sufficient lubricant. Remove housing cover plug and add oil if necessary.

ESSEX INFORMATION

- Wheelbase**
110½ inches.
- Turning Radius**
20 feet.
- Road Clearance**
8½ inches.
- Rear Axle**
Gear ratio—5¼ to 1 Std. 6¼ Spec.
- Firing Order of Cylinders**
1, 5, 3, 6, 2, 4.
- Spark Plugs**
Metric, gap .028 inch.
- Ignition Contact Points**
Opening .020 inch.
- Exhaust Pipe**
1¾ inches diameter.
- Valve Tappet Clearance**
Intake .003 to .005 inch, exhaust .005 to .007 inch, with hot motor.
- Valve Timing**
Intake opens 7° after upper dead center, closes 50° after lower dead center; exhaust opens 55° before lower dead center, closes 8° after upper dead center.
- Oil Reservoir and Troughs**
Capacity 6 quarts; reservoir only, 5 quarts.
- Clutch**
For motors numbered 606868 and upward—Use eight ounces of light motor oil. In winter use six ounces light motor oil and two ounces kerosene.
- Clutch—Continued**
Clearance between pedal and toe board of at least ¾ inch.
- Transmission**
Fill to level of test plug on right side of case.
- Rear Axle**
Fill to level of filler plug in housing cover.
- Cooling System**
Capacity 4¾ gallons.
- Gasoline Tank**
Capacity 11½ gallons.
- Springs**
Front, 36 inches long, 2 inches wide; rear, 54⅞ inches long, 2 inches wide.
- Spring Bolts**
⅝ inch diameter.
- Brakes**
Drums 11 inches inside diameter. 1½ inches wide.
- Storage Battery**
6-volt, 13-plate.
- Lamp Bulbs**
Headlamp, 6-volt, double filament, 21 c. p. for each filament; dome, side, tail and instrument lights, 6-volt, 3-candlepower, single contact; stop-light, 6-volt, 15-candlepower, single contact.

Accessories

The following is a list of manufacturers of accessories used on Essex cars, with whom all matters pertaining to repairs or replacements should be taken up:

Speedometer

Stewart-Warner Speedometer Corp.,
Chicago, Ill.

Battery

The Electric Storage Battery Co.,
Philadelphia, Pa.

Gasoline Gauge

King-Seeley Corp., Ann Arbor, Michigan.

Horn

E.A. Laboratories, Inc., Brooklyn, N.Y.

Starting Motor, Generator, Distributor, Ignition Coil and Switch

The Electric Auto-Lite Company,
Toledo, Ohio.

Vacuum Tank

Stewart-Warner Speedometer Corp.,
Chicago, Ill.

Windshield Cleaner

Trico Products Corp., Buffalo, N. Y.

Tires

Goodyear Tire and Rubber Co., Akron, Ohio.
Miller Tire Co., Akron, Ohio.